

Article number: 20126424RT

Description: E+G Ball knob DIN 319-KU-25-M5-C-RT

Measures

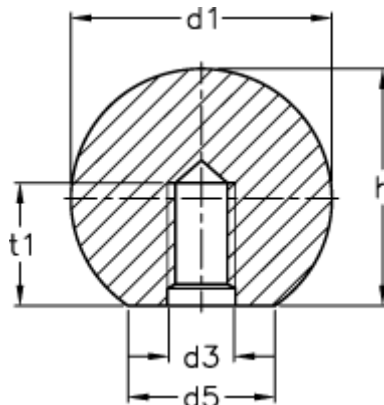

d1	= 25
d3	= M5
d5	= 15
h	= 22.5
t1 min.	= 11.0